

RoHS

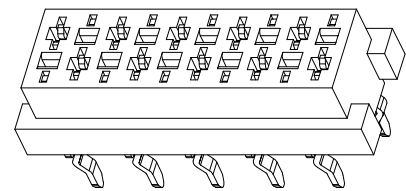

Technical Parameters:  
 Rated current: 1A AC/DC  
 Withstand voltage: 1000V AC/minute  
 Insulation resistance: 1000MΩ min  
 Contact resistance: 20M MAX  
 Operating temperature: -40° C ~ +105° C  
 Insulator Material: PA9T UL 94V-0 Red (红色)  
 Contact Plating: tin over nicker  
 Contact Material: Brass

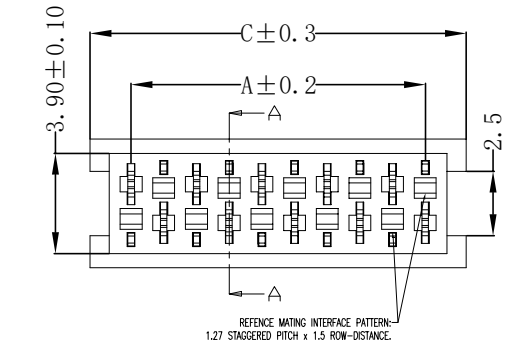
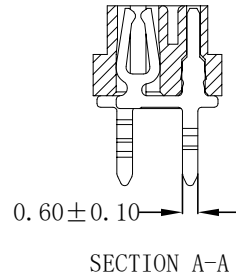
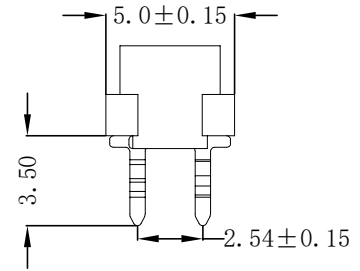
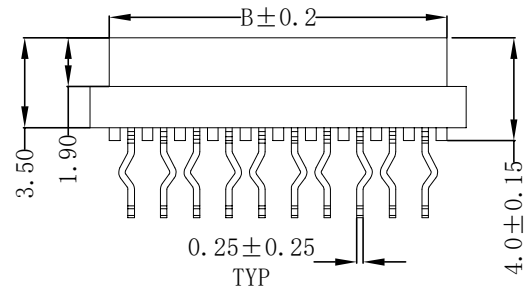

NUMBER OF POSITIONS	DIMENSION		
	A	B	C
04	3.81	5.50	6.99
06	6.35	8.04	9.53
08	8.89	10.58	12.07
10	11.43	13.12	14.61
12	13.97	15.66	17.15
14	16.51	18.20	19.69
16	19.05	20.74	22.23
18	21.59	23.28	24.77
20	24.13	25.82	27.31
22	26.67	28.36	29.85
24	29.21	30.90	32.39
26	31.75	33.44	34.93

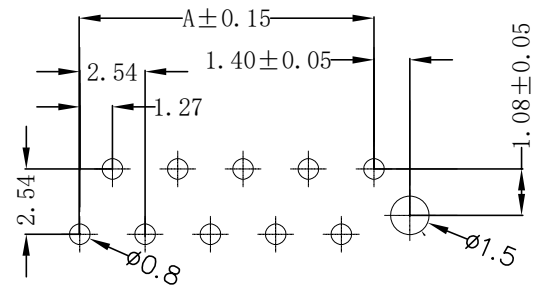
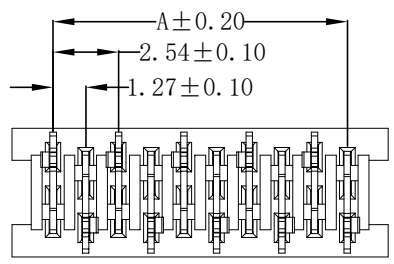

Recommended P. C. Board Layout

东莞市晟凯达电子科技有限公司  
工程专用章

受控

					OPERATION	DRAW	YANG	2016.06.06	SCALE	—	 SCONDAR ELECTRONIC LIMITED	
					X.X ±0.35	DESIGN			UNIT	mm		
					X.XX ±0.25		CHECK	Lisa	2016.06.06	SIZE		A4
AO	2016.06.06	NEW	—	—	X.XXX ±0.15	APPROVE			SHEET	1/1		PART NO.
REV	DATE	MODIFICATION DESCRIPTION	CHANGE	APPROVE	Angle ±3°	DIM	TOL	APPROVE	PROJ.	⌀	TITLE:	IDC Red PH2.54 2xXXPin Tin P9T RD Tray IDC Socket