

1 2 3 4 5 6 7 8 9 10

A

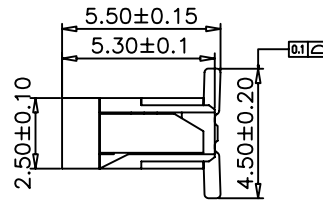
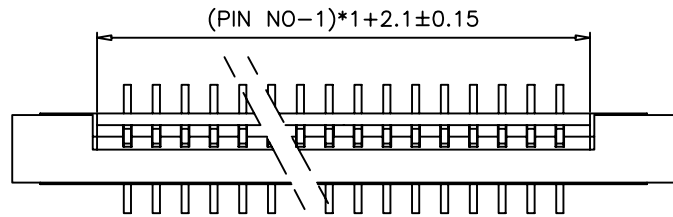

SPECIFICATIONS

Voltage Rating: 50V AC/DC  
Current Rating: 0.5A AC/DC  
Withstanding Voltage: 500V AC/minute  
Insulation Resistance: 500MΩ min.  
Temperature Range: -25° C - +85° C  
Contact Resistance: 30mΩ max  
Poles: 4-60

B

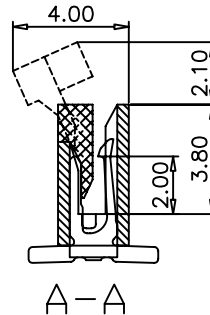
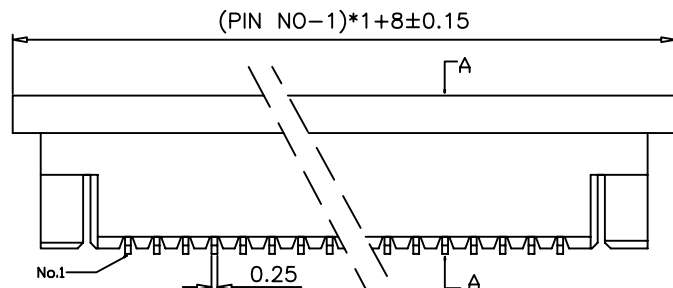

MATERIAL

1. Housing: Nylon46 UL94V-0
2. Locker: PPS, UL94V-0
3. Contact: Phosphor bronze, Tin plated
4. Solder tab: Phosphor bronze, Tin plated

C

D

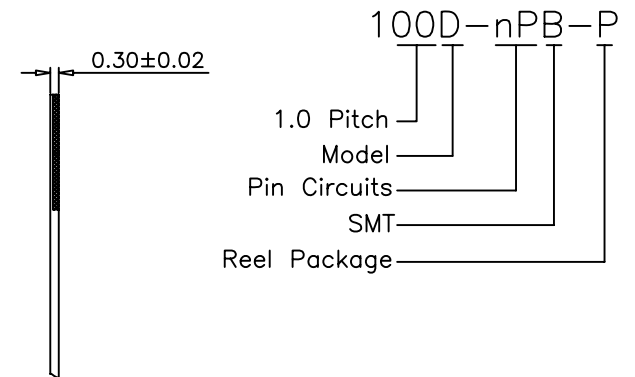
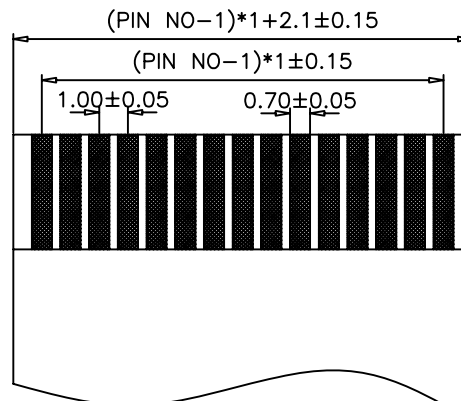
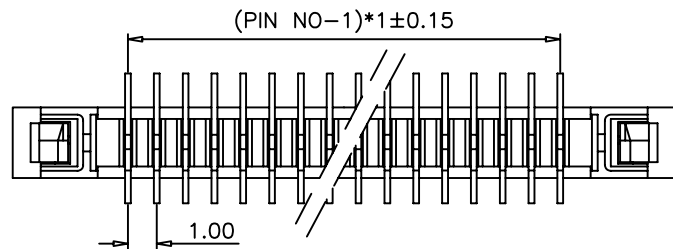

E

F

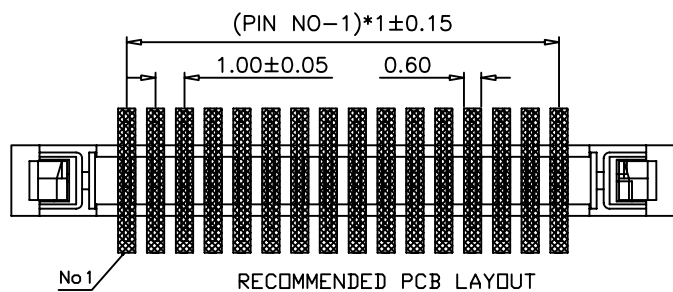

APPLICABLE FFC

G

H

						OPERATION	DRAW	CHENA	14/09/18	SCALE		森康达电子有限公司 SCONDAR ELECTRONIC LIMITED	
						~ 10 ±0.15	DESIGN			UNIT	mm		
						20 ~ 30 ±0.30	CHECK	Micky	14/09/18	SIZE	A4	PART NO.	100D-nPB
0	05/12/27		NEW			30 ~ ±0.50	APPROVE	HELLEN	14/09/18	SHEET	1/1	TITLE:	1.0mm Pitch "D" SMT FPC
REV	DATE		MODIFICATION DESCRIPTION	CHANGE	APPROVE	Angle ± 2'				PROJ.	◆	DRAWING NO.	100D-nPB
						DIM TOL							

1 2 3 4 5 6 7 8 9 10