

1 2 3 4 5 6 7 8 9 10

A
B
C
D
E
F
G

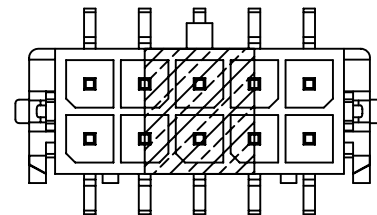
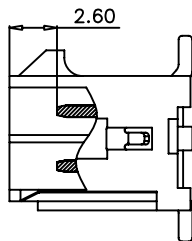
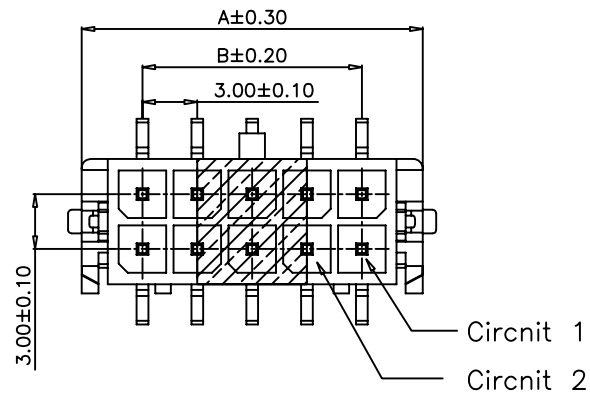

SPECIFICATIONS
 Voltage Rating: 250V AC/DC
 Current Rating: 5A AC/DC
 Withstanding Voltage: 1500V AC/minute
 Insulation Resistance: 1000MΩ min.
 Temperature Range: -25° C - +85° C
 Contact Resistance: 20mΩ max

WAFER
 Part No: SCT3001WV-S-2xXXP
 Poles: 1-12
 Material: LCP UL94V-0
 Pin: Brass, Tin plated

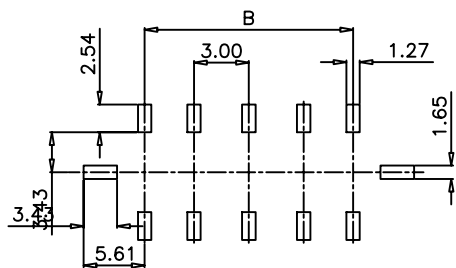
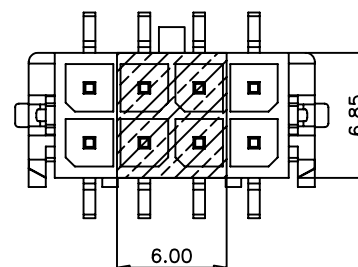
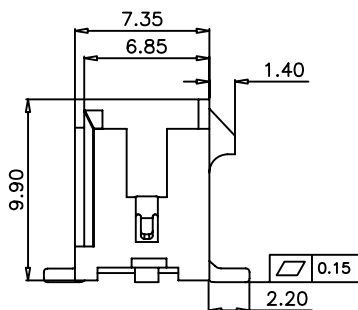
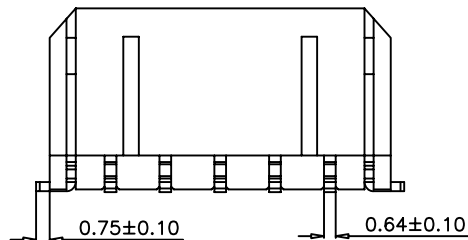

P.C.B.LAYOUT

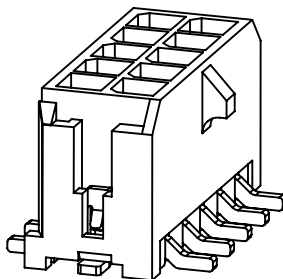

PART NO.	Dimensions	
	A	B
SCT3001WV-S-2x1P	---	6.65
SCT3001WV-S-2x2P	3.00	9.65
SCT3001WV-S-2x3P	6.00	12.65
SCT3001WV-S-2x4P	9.00	15.65
SCT3001WV-S-2x5P	12.00	18.65
SCT3001WV-S-2x6P	15.00	21.65
SCT3001WV-S-2x7P	18.00	24.65
SCT3001WV-S-2x8P	21.00	27.65
SCT3001WV-S-2x9P	24.00	30.65
SCT3001WV-S-2x10P	27.00	33.65
SCT3001WV-S-2x11P	30.00	36.65
SCT3001WV-S-2x12P	33.00	39.65

A
B
C
D
E
F
G

H

					OPERATION	DRAW	SIMON	2014.10.20	SCALE	6:1	森康达电子有限公司 SCONDAR ELECTRONIC LIMITED	
					~ 10 ±0.25	DESIGN			UNIT	mm		
					20 ~ 30 ±0.30	CHECK	MICKY	2014.10.20	SIZE	A4	PART NO.	SCT3001WV-S-2xXXP
					30 ~ ±0.50	APPROVE	HELLEN	2014.10.20	SHEET	1/1	TITLE:	MOLEX3.0 180C SMT WAFER
0	05/12/27	NEW			Angle ± 2°				PROJ.	↔	DRAWING NO.	SCT3001
REV	DATE	MODIFICATION DESCRIPTION	CHANGE	APPROVE	DIM TOL							

H

1 2 3 4 5 6 7 8 9 10