

RoHS

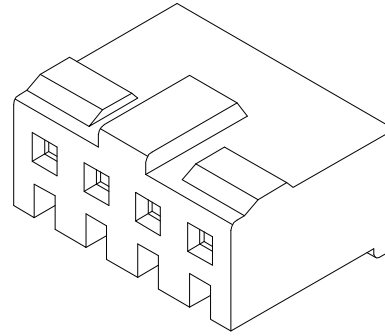

Specification:

- Current Rating: 3A AC/DC
- Voltage Rating: 250V AC/DC
- Insulation Resistance: 1000MΩ Min
- Withstanding Voltage: 1000VAC(1Min)
- Contact resistance: 20mΩ(Max).
- Operation Temperature: -25°C to +85°C

Material:

- Insulator (Housing): Nylon 66 (UL94V-0)
- Color: Brown

Ordering Information

SCT2504H - xx B BN 102

No.of Pins
See Table

Insulation
B=PA66 V0

Color
BN=Brown

10	22.50	25.50			
9	20.00	23.00			
8	17.50	20.50			
7	15.00	18.00			
6	12.50	15.50	15	35.00	38.00
5	10.00	13.00	14	32.50	35.50
4	7.50	10.50	13	30.00	33.00
3	5.00	8.00	12	27.50	30.50
2	2.50	5.50	11	25.00	28.00
Poles	A	B	Poles	A	B
	Dimensions			Dimensions	

2P,3P

4P~6P

7P~15P

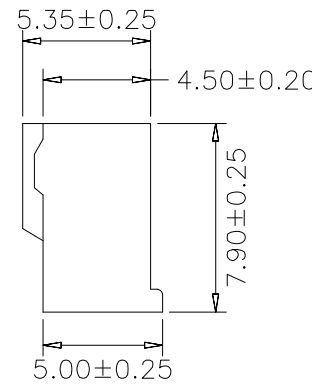
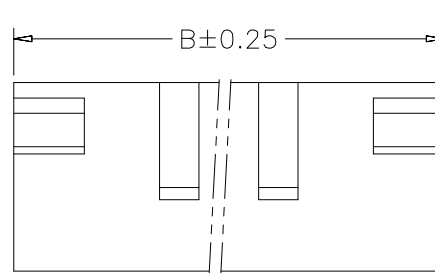
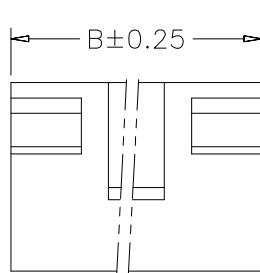
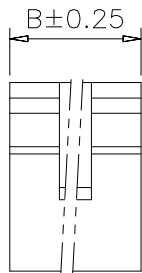
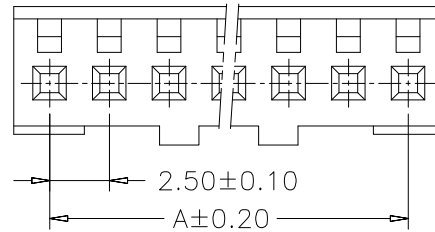
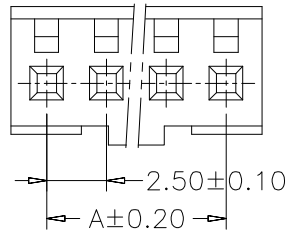
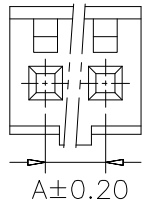

REV	DATE	MODIFICATION DESCRIPTION	CHANGE	APPROVE	OPERATION	DRAW	Peng	2021.07.06	SCALE	-
A1	2021.07.06	Changed from SCT2504H-xxP to SCT2504H-xxBBN102			X.X	±0.35			UNIT	mm
AO	2009.10.15	NEW			X.XX	±0.25			SIZE	A4
					X.XXX	±0.15		2021.07.06	SHEET	1/1
					Angle	± 3'			PART NO.	SCT2504H-xxBBN102
					DIM	TOL		2021.07.06	PROJ.	TITLE: JAE 2.50mm Pitch Housing Connector

SCONDAR ELECTRONIC LIMITED
 PART NO. SCT2504H-xxBBN102
 TITLE: JAE 2.50mm Pitch Housing Connector